

NE900 Series Specifications				
		NE910	NE930	NE950
Main Body	Optical System	Infinite Optical System		
	Eyepiece	SW10x/25, SW10x/22, EW12.5x/17.5, WF15x/16, WF20x/12		
	Focusing System	Coaxial Coarse and Fine Adjustment, Fine Division 1 um, Moving Range 35mm		
	Illumination	12V/100W Halogen Lamp 3W S-LED Lamp		
Viewing Head	- GC900B Seidentopf Binocular Viewing Head; - GC900 Seidentopf Trinocular Viewing Head, Eyepiece/Port: 100/0, 20/80, 0/100 Inclined at 30°, Interpupillary Distance 47-78mm - GC900E-1/-2 Ergo Tilting Trinocular Viewing Head, Eyepiece/Port: 100/0, 20/80, 0/100 Adjustable from 0° to 35°, Interpupillary Distance 47-78mm			
Nosepiece	SZ21A Sextuple Nosepiece	SZA20A Motorized Sextuple Nosepiece		
Stage	- PT6A-L/R Stage with Gorilla Glass Insert - PT6B-L/R Stage with Sapphire Glass Insert Moving distance:78(X)x32(Y)mm, 1mm/grid, precision: 0.1mm; The stage control knobs can be adjusted up or down by 18mm, and with adjustable tension control; The convex spot design on clip is convenient to place slides with one hand.			
Condenser	- SJ5 Swing-out Condenser - XC8 Turret PH Condenser - DFC Dry Dark-field Condenser - DFC-O Oil Dark-field Condenser	-SJ7 Motorized Condenser		
Epi-Fluorescent Attachment			- FL-VI Epi-Fluorescent Attachment	
Fluorescent Illumination			- Osram Mercury Lamp HBO 100W - Metal halide illumination 75W - LED FL	
Optional observation model	Bright field, Dark field, Phase contrast, Fluorescence, Polarization, DIC			

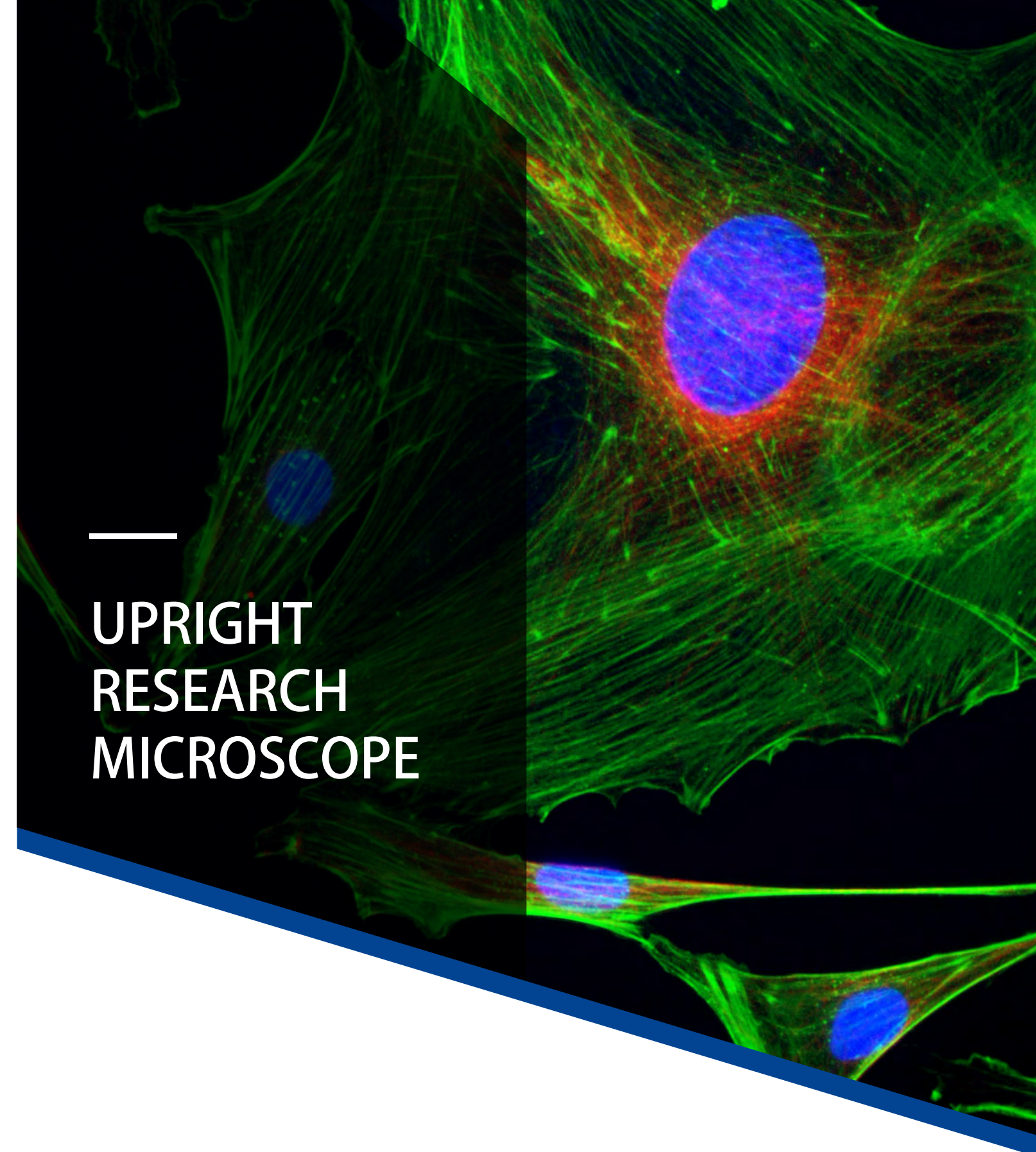

Nexcope[®]
Scientific research microscope

Nexcope

Nanjing Jiangnan Novel Optics Co., Ltd.

Add: No. 9 Hengda Road, Economic-Technological Development

Area, Nanjing 210038

Website: <http://www.jnoec.com>

Whatsapp:+86 15335123985

Skype live:.cid.c47ec013e33fc266

TEL:86-25-87720028

NE900 SERIES
UPRIGHT RESEARCH MICROSCOPE

Nexcope[®]
Scientific research microscope

Nexcope NE900 Series

Intelligent / Comfort / Accuracy



NE950
Automatic Fluorescent Microscope



NE910
Manual Microscope



NE930
Automatic Microscope

Accurate Imaging, High Color Reduction

Nexcope NE900 series upright biological microscopy adopts NIS infinite for optical system, which has been studied for many years and constantly improved. It has excellent optical quality, such as long working distance, strong color difference correction ability and so on.

Ergonomic Design, Comfortable Operation

Laboratory & Inspection and screening work means that microscopes need to be used for a long time. Nexcope NE900 series microscope adopts ergonomic design and man-machine design to reduce muscle tension and visual fatigue caused by repetitive operation, and to make boring work easier and easier.

Modular Design to Realize the Diversity of the Observation Method

Nexcope NE900 series microscope adopts modular design, which can realize the observation methods of field, dark field, DIC, fluorescence, polarized light and so on. It is a perfect tool for experimental teaching, scientific research and medical examination.

Energy Conservation and Environment Protection, Increasing Service Life

The transmitted light would be off automatically after 30 minutes from operators leave. It can not only save energy, but also keep the lamp life.

Ergonomic Design

NE910

The excellent optical performance and comfortable operation experience is worth believing by the scientific research workers a scientific research partner. The infinite for optical system, which is the mainstream optical system of scientific research microscope, makes it possible to realize many kinds of observation methods. And the perfect Kohler lighting provides a bright and uniform field of view for the microscope. On this basis, Nexcope continues to optimize the customer product experience, NE910 in line with ergonomic design, so that observation and operation can maintain a comfortable posture.



Easy to Customize

Adjustable Control Knobs

The height of the stage control knobs can be adjusted up or down by 18mm to ensure a comfortable hand position, and with adjustable tension control.

Rise 18mm



The Left / Right Hand Position Operate

Customers can choose the position of the fine focusing knob to be right or left, according to preferences.



Comfort in Operation

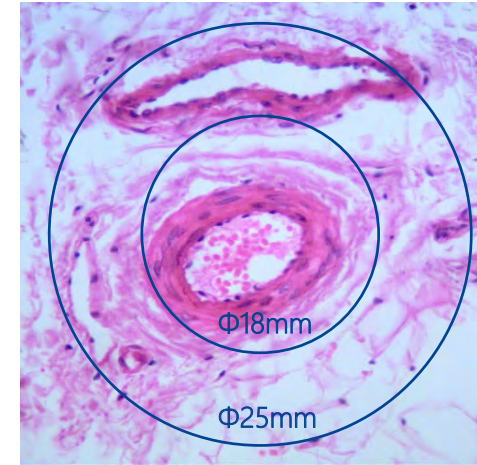

Wide-field Eyepiece

NE900 uses a large field of view eyepiece with field of view 25mm. The field of view is larger, the observation content is more comprehensive, and the sample observation is faster. For samples that require panoramic views, a microscope with a large field of view is a more correct choice.

Comfortable to Use and Easy to Operate

Put Slides by One Hand

It is easy for operators to put slides by one hand due to the convex point place design on clip.



Adapter to Lower Stage Position

To lower the stage by 1 “, by adding a block up the nosepiece, so that operators can change the slides position easily and comfortably.



Low-position Control Knobs

Ergonomic design, to give you the maximum degree of comfort.



Automatic Design

NE930

On the basis of NE910, a variety of electric components are added, which simplifies the repetitive operation, improves the working efficiency and makes the scientific research work easier. Nexcope series microscope, intelligent product, is designed to bring revolutionary breakthrough for laboratory and clinical microscope operation and application. The NE930, on the basis of ensuring excellent optical performance and exquisite human engineering design, adds a plurality of convenient and humanized designs so that the microscopic observation is more comfortable, the magnification conversion is more convenient, and the image shooting is more rapid.



Microscopic observation is more comfortable

Ergo Tilting Trinocular Head

Eye tube can be adjustable from 0° to 35°, Trinocular tube can be connected to SLR camera and digital camera, having a 3-position beam splitter (0.100, 100:0, 80:20), the splitter bar can be assembled on the either side according to user's requirement.



Light Intensity Management Function

When converting objective lenses with different magnification, the illumination intensity needs to be adjusted to ensure the same illumination brightness in the field under different magnification. NE930 can intelligently remember the appropriate light intensity under different magnification, and automatically adjust with the change of objective lens magnification, it can reducing fatigue.

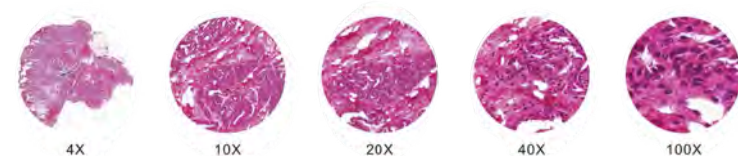

Efficiency in Operation

Easier to Get Image



Image Capture Button

The digital camera could capture images just by pressing the black "capture" button at the side of the bottom of the microscope body.

The Conversion Rate is More Convenient

Remote Control Pad

Objectives could be switched by simply pressing the rotating buttons. Users could also self-define two of the most commonly used objectives. User could swap between these two objectives by pressing the green button.



Nosepiece Rotating Buttons

This microscope has the function of automatically rotating nosepieces and adjusting the light intensity.



Motorized Swing-out Condenser

Automatically swing-out and swing-in the top-lens element according to the objective lens that is selected via the intelligent linking.



Fluorescent Image with Bright Color and Dark Background

NE950

On the basis of NE930, a reflective fluorescent vertical illuminator is added. At the same time, high numerical aperture, high definition semi-complex achromatic fluorescent objective lens and high cutoff and high transmittance fluorescent filter group are used to produce fluorescent images with bright color and dark background.



Microscopic Observation is More Comfortable

Turret Filter Module

The fluorescent turntable can install 6 color filter groups and can image the specimens with multiple staining at the same time. At the same time, the conversion excitation module only needs a small dial, which is convenient and fast, improves the working efficiency and effectively reduces the dye quenching.

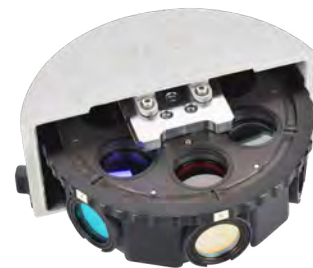

Epi-Fluorescent Attachment

Standard osram 100W HBO ultra-high pressure spherical mercury lamp, high fluorescence brightness, uniform field of view.



Metal Halide Illumination

Optional 75W metal halide illumination, bulb life up to 2000 hours. The intensity of light is greater and the field of view is brighter and more uniform.

A Fluorescent Image of A Bright Color and Dark Background

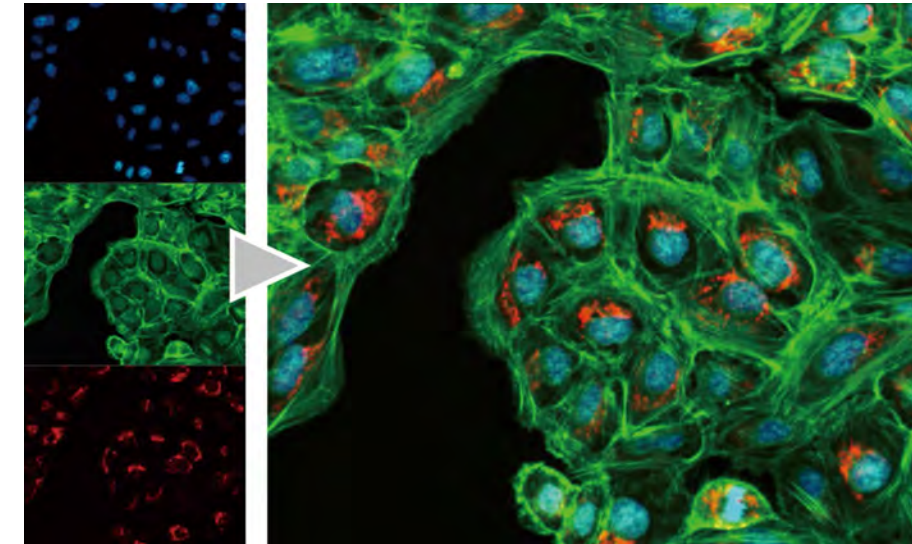

Clearer and Brighter Image

Nexcope has devoted many years to the study of fluorescence imaging. The infinite S-APO fluorescent objective is used in NE950 to ensure the sharpness, clarity and color reduction of the image. At the same time, the latest advanced sub-corrugation elimination coating technology is adopted, so the apparent fluorescence transmittance is higher, the cutoff is more acute and the testing efficiency is higher. It is the correct choice for visible to ultraviolet fluorescence imaging.



Focus on Detail and Extend Service Life

Sapphire Glass Stage Insert

Mechanical stage with a gorilla glass insert is durable and allows operators to easily clear the stage. We have sapphire glass for your optional choice.



Intelligent Fluorescent Power Supplier

Automatic memory time and shutdown time, when misoperated, effectively protect the service life of mercury lamp

Fluorescent Filter: High Accuracy and Easy to Use

In order to make the fluorescence transmittance higher, the cut-off more acute, and the detection effect better, we adopted the excellent secondary ripples elimination coating technology on the fluorescent filter group. High sensitivity fluorescence detection makes cells less exposed to excited light, and higher signal-to-noise ratio (S / N) produces fluorescent images with bright colors and dark background.



NIS Series Objective: With Excellent Optical Performance

After many years of efforts, a number of optical objective lenses with excellent optical properties have been developed. Which has high numerical aperture, long working distance and excellent chromatic aberration correction capability. Meanwhile, the multi-layer coating technology is adopted, so that the sharpness, the definition and the color reducibility of the image are ensured, and a high-quality and high-performance solution is provided for digital imaging.

N-PLN Series Plan Objectives

These plan objectives can provide flat image through the light from visible light to NIRS. They are usually used for bright-field viewing as the high signal-to-noise, high resolution and high contrast image result.



N-PLFN Series Plan Fluorescent Objectives

Owe to the multilayer coating technology, these S-APO objective can compensate the spherical aberration and the chromatic aberration from ultraviolet to infrared. High-sensitive fluorescence ensure the acuity, articulation and color reduction of image, to provide the digital image of high-quality and high-function.



N-PLM PH Series Plan PH Objectives

They are the good choice for clinic and scientific research. These high-quality plan objective can provide advanced plan image of 25mm FOV under bright field & transmitted light. NIS60 series plan phase contrast objectives are specially designed for phase contrast viewing.



N-PLM Series APO Objective

The new APO objective has a high-level chromatic aberration correction capability and a high resolution, and ensures the high-level wave phase difference correction function of the whole field of view, which is an ideal choice for routine laboratory observation and digital imaging objective.



Bright / Clear / Practical

Multi-viewing System

The multi-viewing microscope system is widely used in the teaching, experimental training and pathological diagnosis of the university. The Nexcope series of accessories can be expanded by 1 -10 people, and the microscopic image can not be distorted and the brightness of the image can not be lost. Cooperate with teaching head and built-in indicator needle to facilitate learning and diagnosis.



2-Head Multi-Viewing (Face to Face)



2-Head Multi-Viewing (Side by Side)



5-Head Multi-viewing



10-Head Multi-viewing

Building Block Design

Nexcope scientific microscope can achieve a variety of observation methods through modular combination: bright field, dark field, phase contrast, fluorescence, polarization, DIC and so on.

Bright Field Observation

Nexcope adopts scientific research grade optical system in scientific research grade microscope. NIS infinite optical system, which provides a reliable guarantee for optical quality. At the same time, the flat field achromatic objective lens with high numerical aperture is used to provide a clear and flat image with the perfect combination of NIS optical system.

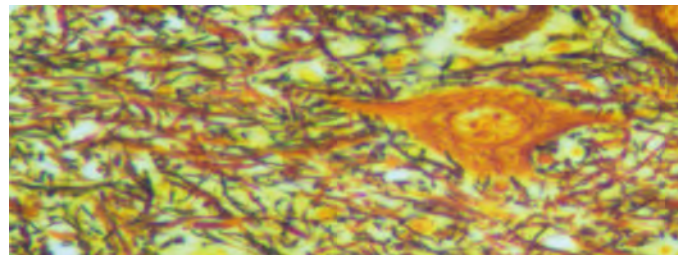

Spinal cord Silver-plated dyeing 20 ×

Brown filamentous nerve fibrils were found in the cell bodies and processes of multipolar neurons, and synapses were seen around the cell bodies.

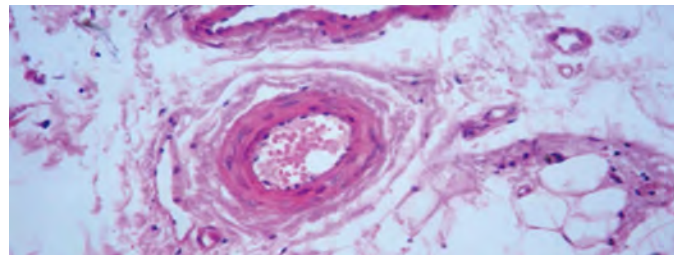

Artery H.E. Staining 20 ×

In the connective tissue of the outer membrane of the aorta, a small artery, a small vein and a capillary are seen.

Polarizing Observation

It is very suitable for observing birefringent specimens, such as collagen, starch protein, crystal, liquid crystal or plastic glass.

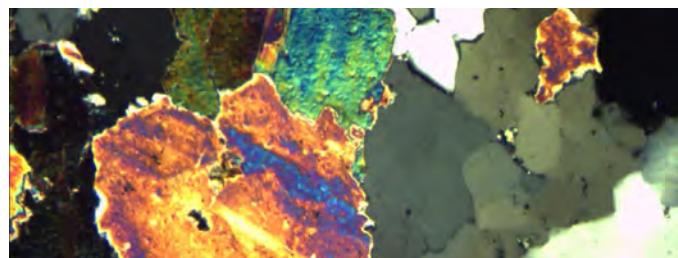
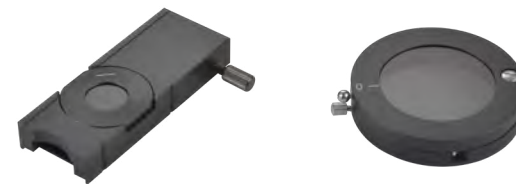

Crystal

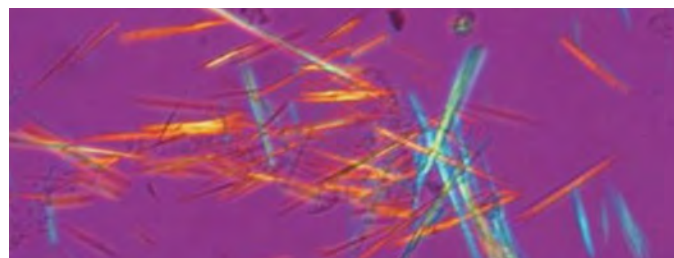

Uric Acid Crystal

Fluorescent Observation

The noise elimination device is used in the drop-out fluorescent attachment, and the captured fluorescence image is bright, the contrast and the signal-to-noise ratio (S/ N) are high. The series of fluorescent light sources of the microscope are available for selection, and the light source of the mercury lamp has high cost performance. The metal halide lamp has long service life and wide application range. The LED light source has little damage to the sample, and the service life can be more than 10,000 hours.

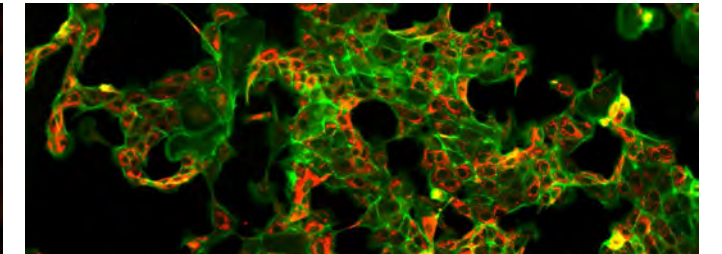
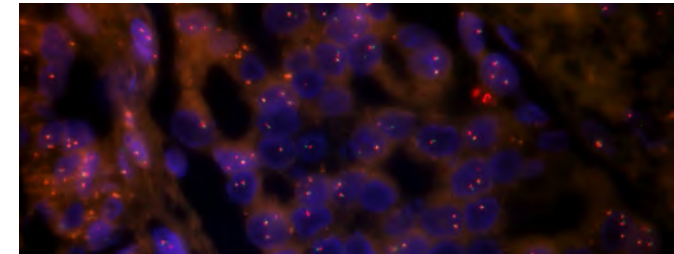

Diagnostic analysis of breast cancer, using Alexa 488\Spectrun Green\Spectrun Orange dye, images taken with NE950 fluorescence microscope 40X lens

Phase Contrast Observation

This observation is suitable for viable cells without staining.

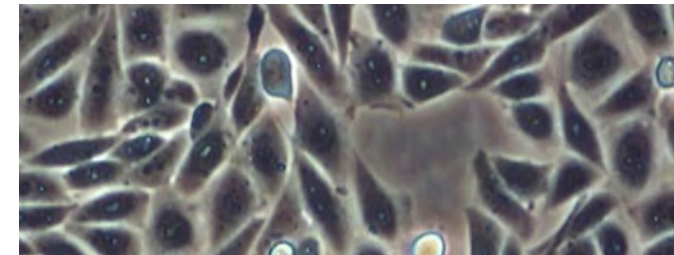

Rat Ovarian Cell

Dark-field Observation

It can be used for clearly viewing of blood or flagellum etc. fine structure.

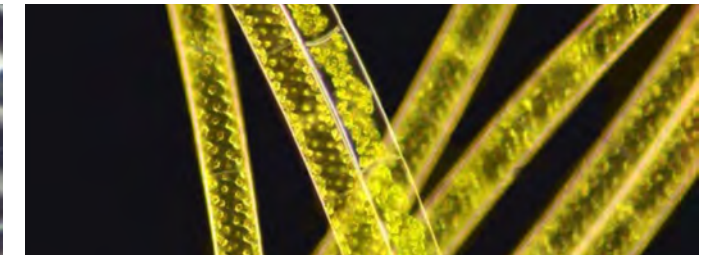

Spirogyra

DIC Observation

DIC increases the contrast of the sample and makes the nucleus and larger organelle such as mitochondria have a strong stereoscopic sense, which is more suitable for micromanipulation. The present invention is mainly used for micro-operation of gene injection, nuclear transfer, transgenic animal and other biological engineering.

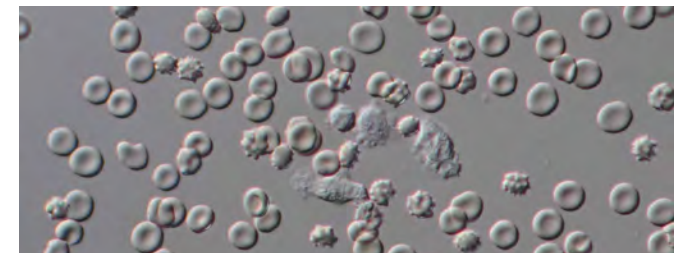

Red Blood Cells and White Blood Cells



Saccharomyces Cerevisiae

NE900 Series System Diagram

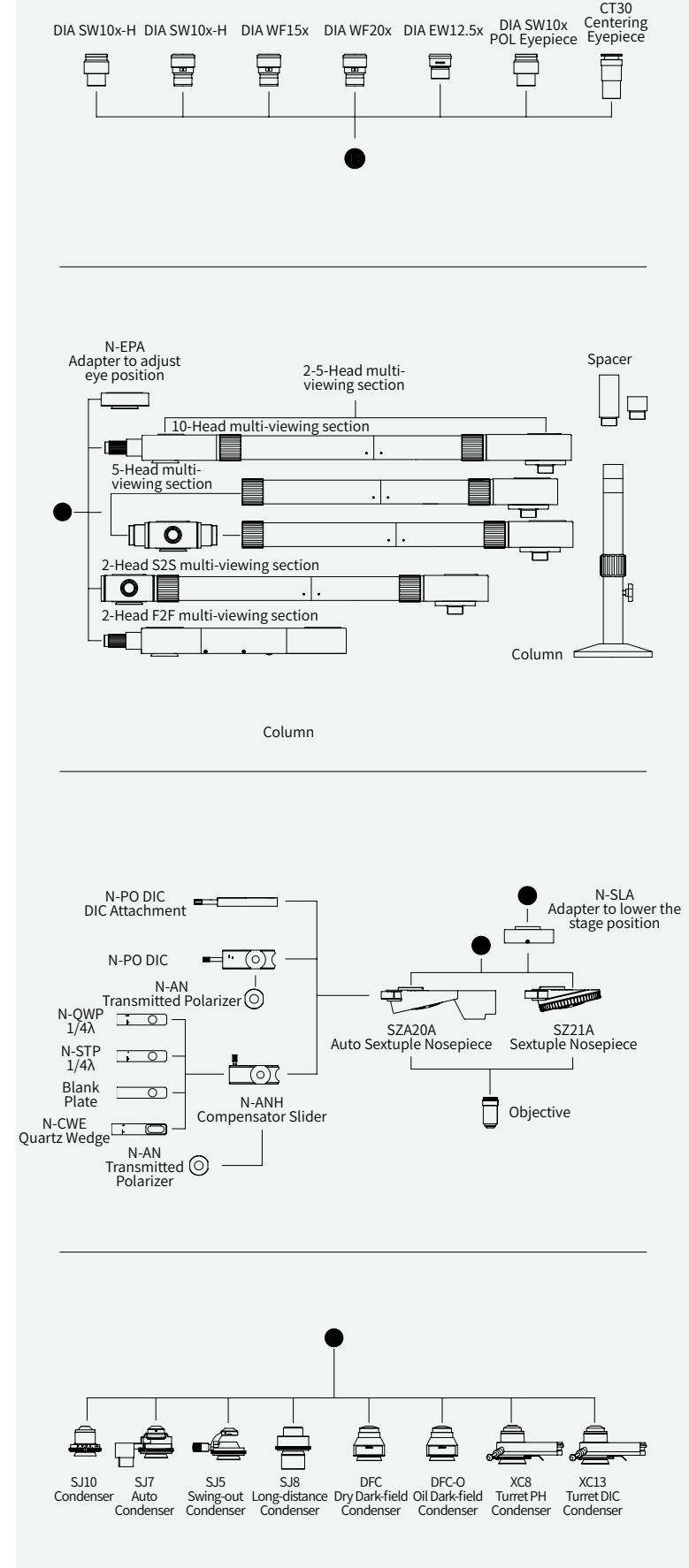
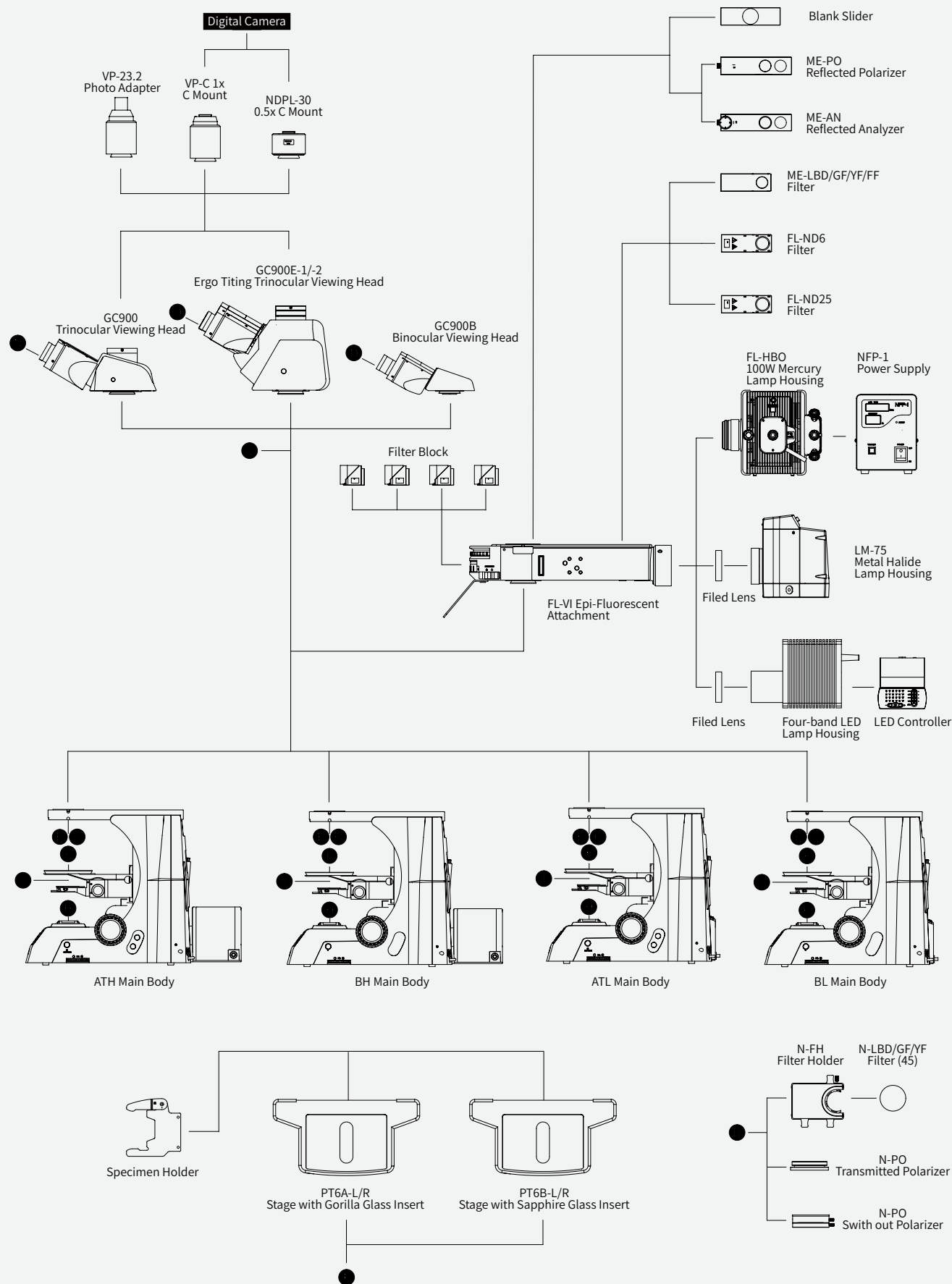

NE910 Dimensions Unit: mm

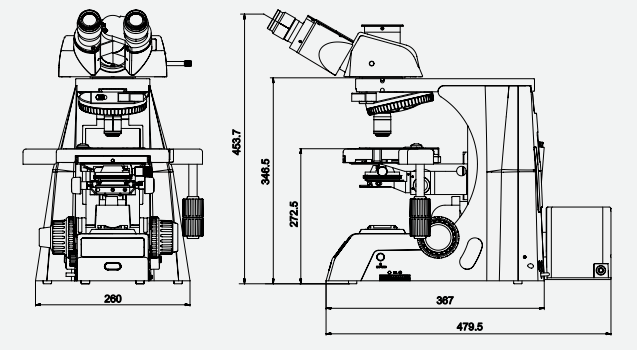

NE930 Dimensions Unit: mm

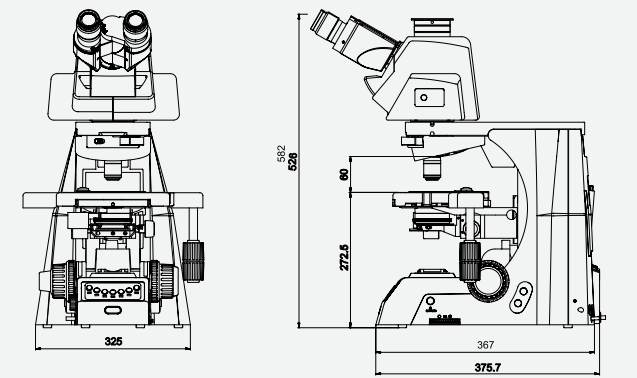

NE950 Dimensions Unit: mm

