

NIB900 Series Inverted Microscope Specifications					
	NIB910	NIB920	NIB910-FL	NIB920-FL	NIB950
Optical System	NIS Infinite Optical System				
Eyepiece	-SW10X/22 ·SW10X/25 ·EW12.5X/17.5 ·WF15X/16 ·WF20X/12				
Viewing Head	Seidentopf Trinocular Head(build-in bertrand lens),inclined at 45°, Interpupillary Distance 47-78mm				
Objective	·N-iPLEN PH Plan S-APO Phase Contrast Objective 4X、10X、20 X、40X、60X ·N-iPLEN Plan S-APO Objective 10X、20 X、40X、60X				
Nosepiece	Sextuple Nosepiece with DIC Prism Slot	Encoded Sextuple Nosepiece with DIC Prism Slot	Sextuple Nosepiece with DIC Prism Slot	Encoded Sextuple Nosepiece with DIC Prism Slot	Electric Sextuple Nosepiece with DIC Prism Slot with objective lens protection function during rotation
Condenser	Long Working Distance Turret Condenser,NA0.55, WD=26mm, with 6 Modules for Phase Contrast, DIC and Brightfield			Long work distance electric Turret condenser,NA 0.55, WD=26mm,with 6 Modules for Phase Contrast, DIC and Brightfield	
Illumination	Transmission lighting	Kohler Illumination, 12V/100W halogen lamp. Kohler Illumination, 10W LED			Kohler Illumination, 10W LED
	Epi-Illumination	100W mercury lamp. 10W LED fluorescent lighting. Metal halide lamp			
Focusing System	Coaxial Coarse and Fine Adjustment, Moving Rang 9mm (up 2mm, down 7mm), Coarse Stroke 2mm per Rotation, Fine Stroke 0.2mm per Rotation			Electric coaxial coarse inching lifting mechanism, moving stroke 9mm (up 7mm,down 2mm), Minimum resolution 0.02 μm(grating type), motion repetition positioning accuracy: ± 0.1μm, It has the function of preventing the mechanical sliding of the platform	
Stage	3 Layers Mechanical Stage, Moving Range 130x85mm, Flexible Knob, available for Different Size Small Stage.			Electric control (grating type): stroke range 130 mm x 100 mm Platform size 325 mm x 144 mm, maximum speed: 10mm / s Resolution: 0.1 μm, repetition accuracy: ± 0.5 μ m Small worktables of different sizes can be installed on the top platform according to requirements	
Auxiliary Stage	Terasaki plate, φ38mm,φ54mm plate, General support plate, 96-hole plate tray				
Intermediate magnification	Multiplier 1X, 1.5x			Multiplier 1X, 1.5x, CF file	
Image Output	Port switch turntable (left side port / right side port / visual observation), Spectral ratio: left side/eyepiece = 100/0; Right side/eyepiece =80/20; optional/visual=0/100			Port switch turntable (left side port / right side port / visual observation), Spectral ratio: left side: eyepiece = 100/0; Right side: eyepiece = 100/0	
Display	-	4.3-inch microscope service status display	-	4.3-inch microscope service status display	-
Observation Method	Bright field, Phase contrast, DIC		Bright field, Phase contrast, DIC, Fluorescence		
Epi-fluorescent attachment	Filter Turntable	-		Epi-fluorescent filter turntable	Encoded Epi-fluorescent turntable
	Fluorescent Illuminator	-		With high-performance filter Can be equipped with up to six Epi-fluorescent filters, Use one position during bright field observation center align reflected light field of view stop of aperture stop Three-hole filter plate NFP-1N 100W Intelligent mercury lamp power box	Electric Epi-fluorescent filter turntable With high-performance filter Can be equipped with up to six Epi-fluorescent filters, Use one position during bright field observation center align reflected light field of view stop of aperture stop Three-hole filter plate NFP-1N 100W Intelligent mercury lamp power box

INVERTED RESEARCH MICROSCOPE

NANJING JIANGNAN NOVEL OPTICS CO., LTD.

Add: No.9 Hengda Road, Economic-Technological Development Area, Nanjing, China P.C.: 210038

Tel: +86-025-87720110 Fax: +86-025-85800086

<http://www.jnoec.com>



NIB900

SERIES

Nexcope[®]
Scientific research microscope

NIB900 series

Scientific Research Inverted Biological Microscope

NIB900 is a scientific research inverted microscope designed for advanced life science research to meet your various needs. It is an omnipotent microscope, which can observe bright field, phase contrast, polarized light, DIC, fluorescence and other observation modes. Even the confocal, superresolution, and so on needed for cutting-edge life science research can be achieved with this microscope.

Fully consider the user's operation habits, ergonomic design, greatly reduce the mechanical fatigue caused by long time observation work. NIB950 adopts high-speed electric control, which simplifies and visualizes complex operation and makes it easier and simpler to operate.



NIB950

All-motorized Microscope

Multiple motorized Parts for Fast Automatic Operation



NIB910

Basic Scientific Research Inverted Microscope

It can realize bright field, phase contrast, DIC and other observation methods.



NIB910-FL

Fluorescence scientific research inverted microscope

Based on NIB910, the fluorescence observation function is upgraded

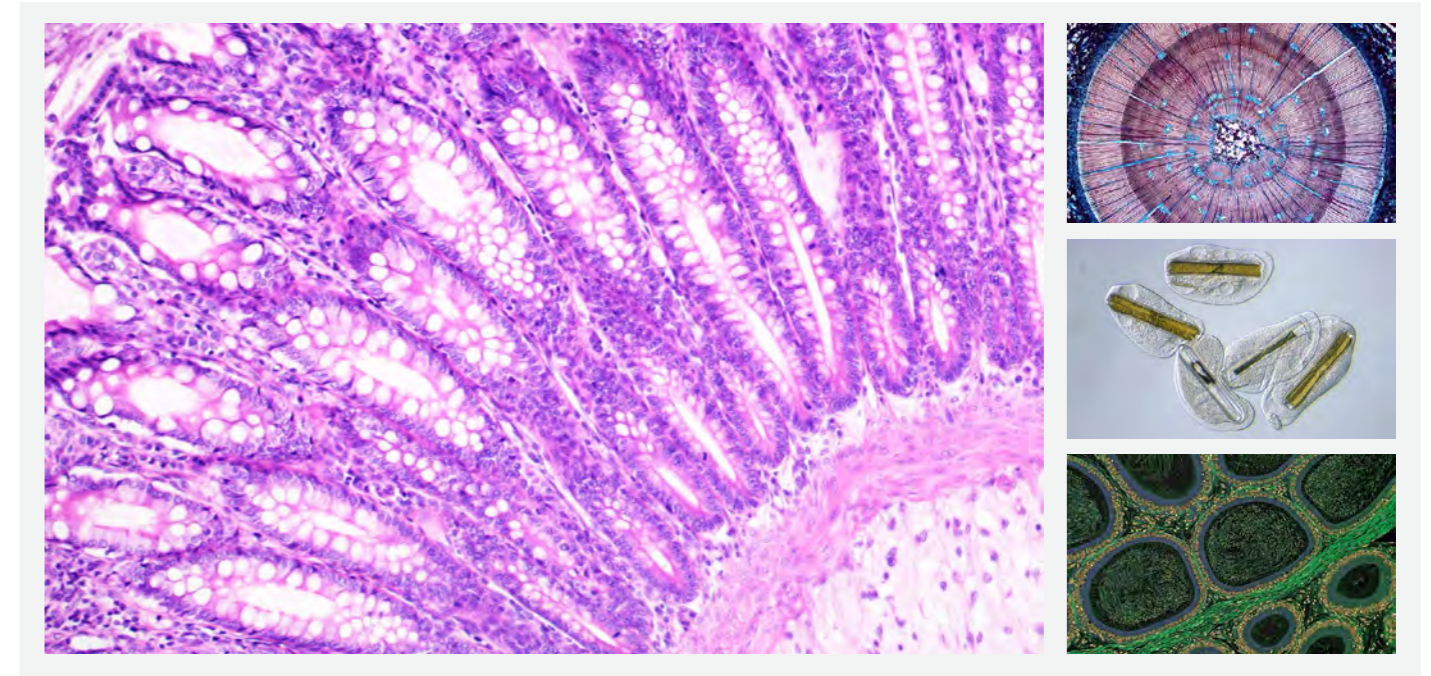

Bright Field

Modular design provides a variety of flexible imaging methods

Bright Field Observation

Unique NIS infinite optical system, combined with the semi-apochromatic fluorescent objectives, effectively eliminates imaging problems such as curvature of field, chromatic aberration, spherical aberration, coma and other imaging problems. The image is brighter and all magnifications are available in higher super resolution and flatness.

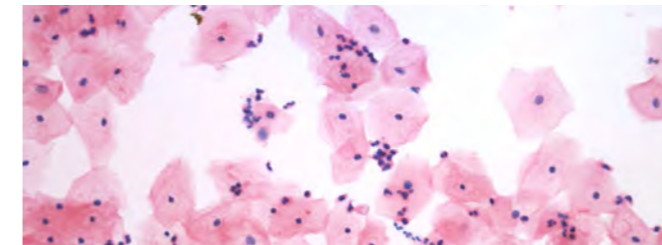

Phase Contrast Observation

Phase contrast is an optical contrast technique that uses a phase contrast objective and a concentrating ring. High-efficiency halogen lamps provide a bright light source for the system and clear images even at high magnifications.

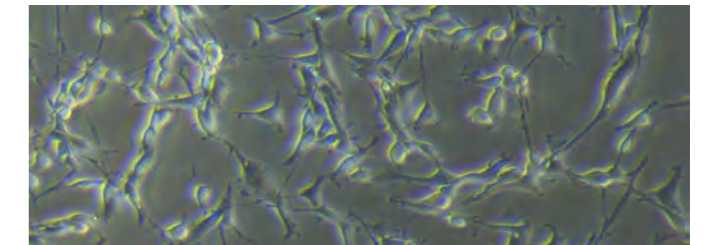

DIC

DIC is a cost-effective optical technology that does not require expensive optics. The embossing contrast uses only the bright field objective and two phase contrast adjustment sliders; For thicker samples, such as induced pluripotent stem cells, DIC provides a pseudo three-dimensional glare-free image. Halo is usually seen with traditional phase contrast observations. In addition, DIC can use glass culture dishes, which is a highly applicable observation technique.

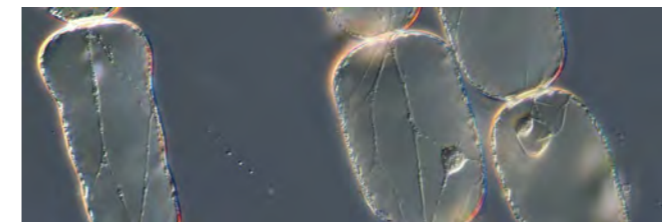

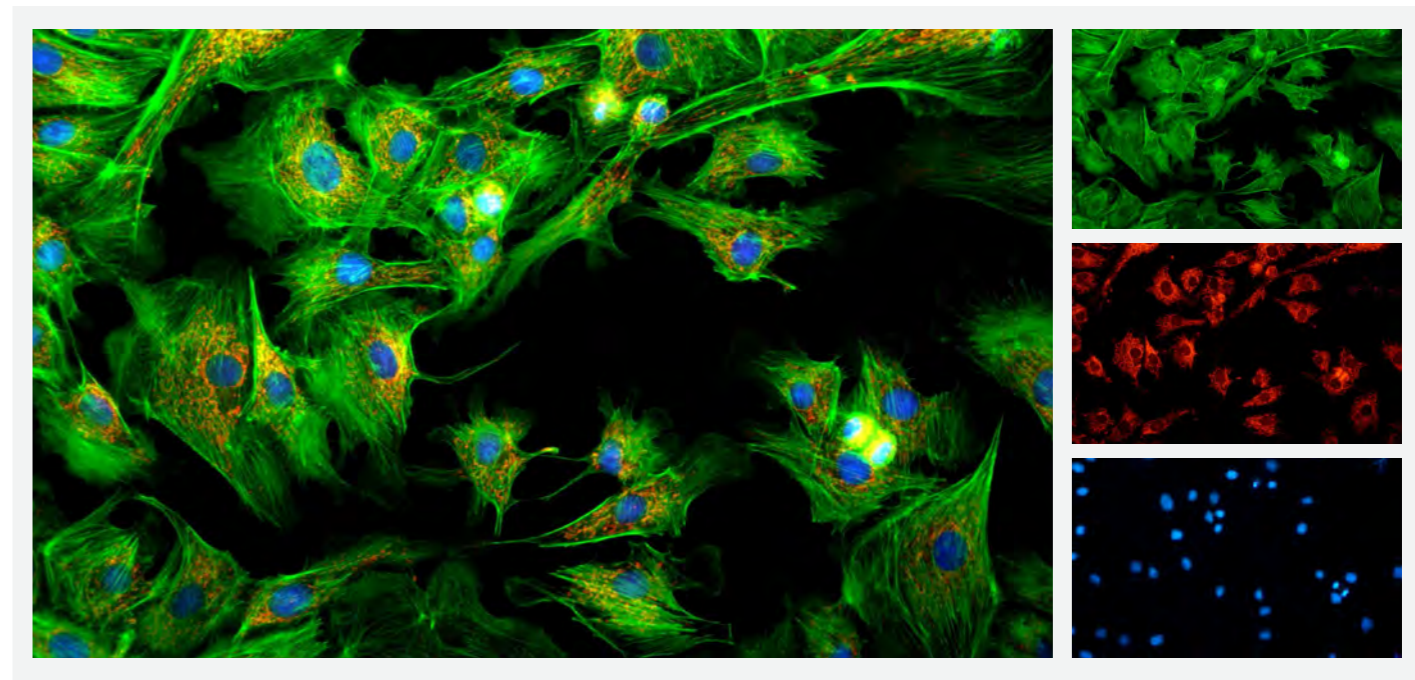

Fluorescence

Provide you with reliable, clear, high resolution fluorescent images

Adopt The Latest Coating Technology

Using the latest advanced secondary corrugation elimination coating technology, the cutoff is sharper, the fluorescence transmission rate and detection efficiency are higher.

Fluorescence Observation is More Comfortable

All the fluorescent filter components are equipped with ultra-high performance color filters. The fluorescent lighting strut is capable of installing six color filter banks, capable of imaging a variety of stained specimens at the same time. High sensitivity fluorescence can achieve bright and high contrast imaging results. Leading coating technologies also reduce scattered light and spontaneous fluorescence, ensuring a higher noise ratio.



FITC FILTER SET

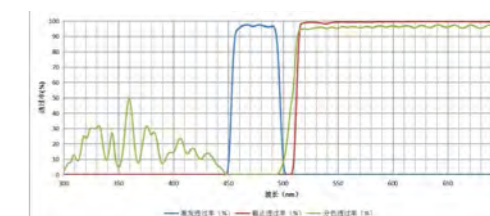

DAPI FILTER SET

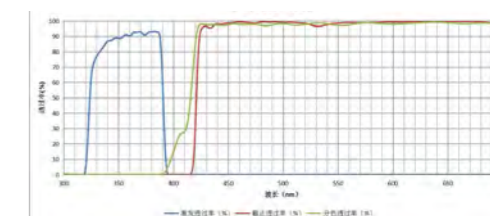

TRITC FILTER SET

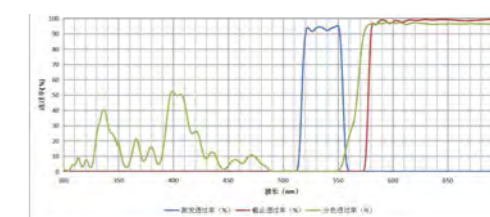

B/G FILTER SET

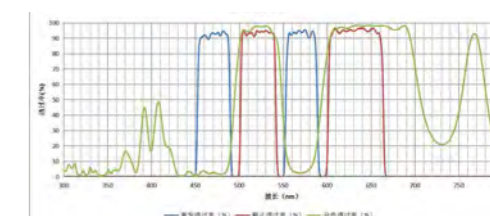

NIB950

A variety of electric components combined to achieve fast reading and accurate operation

You can use the software to control various electric parts of the microscope, such as objective conversion, focus, condenser conversion, fluorescence module conversion, etc. The quick and easy operation of this scientific research grade inverted microscope not only increases your work efficiency, but also reduces the exposure time of cells, reduces phototoxicity, and obtains more accurate and valuable experimental results.

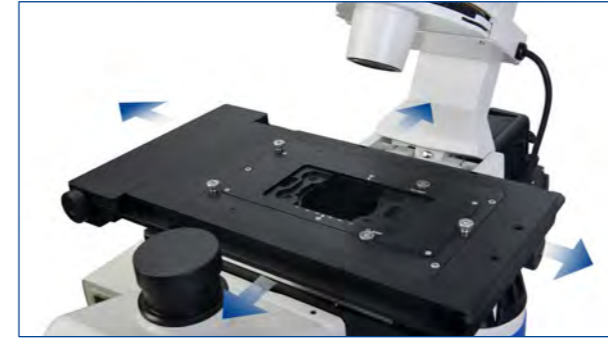

■ XY Axis Electric Stage

Large stroke, high precision, fast positioning, suitable for multi-point observation.



■ Z-axis Autofocus

Fast and accurate Z axis control.



■ Electric Condenser Turntable

Conversion of electric condenser module can be carried out.

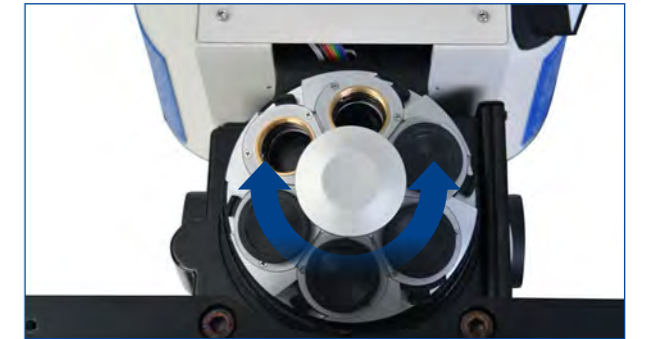

■ Electric Objective Converter

Can realize 6 objective conversion at will.

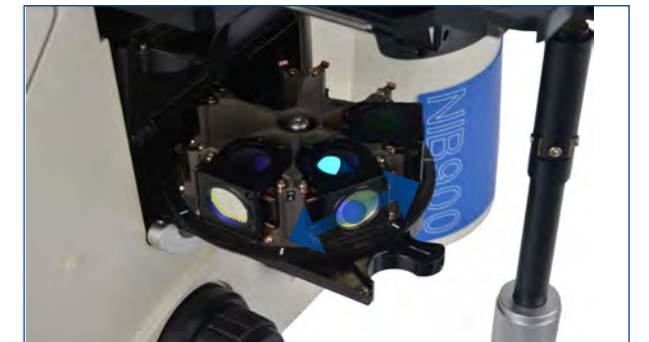

■ Electric fluorescent module turntable

Can realize 6-hole fluorescent module conversion at will.



■ Joystick module

Flexible positioning of electric stage.

Clear Observation with a Variety of Fluorescent Dyes

Fluorescent excitation module rotary type: more relaxed, more flexible

Multi-function six-station rotating disc structure, easy to take out from the host, convenient to replace all kinds of fluorescent excitation module

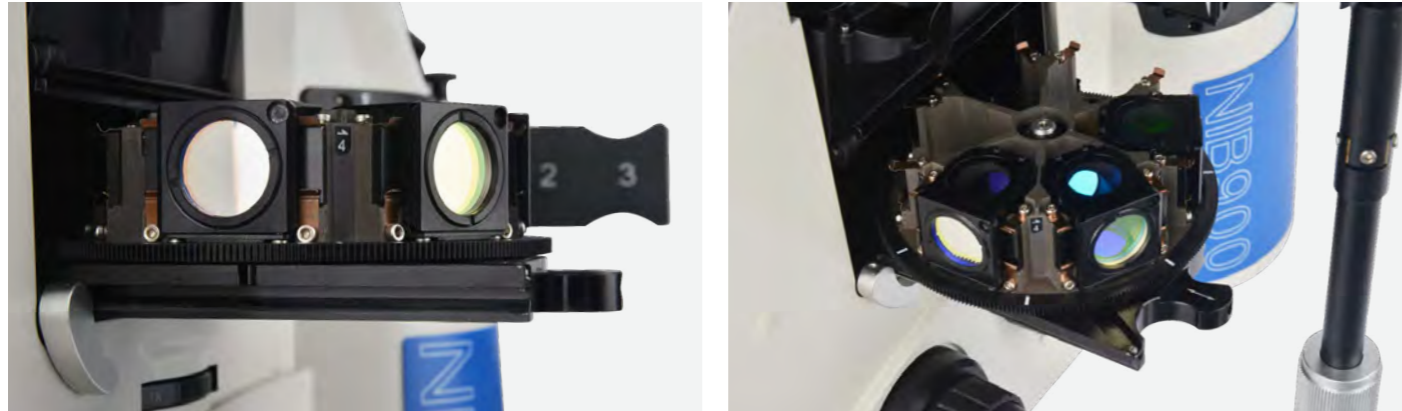

Simple and fast operation, NIB900 diaphragm slider

Three different types of light bar sliders, reflecting field stop, aperture stop and filter plate, demonstrate NIB900's versatility in living cell research. In combination with the aperture aperture and the fluorescent filter plate, the optimal fluorescence intensity can be adjusted according to the selected fluorescent module and objective.



Power Supply for HBO Mercury Lamp

The power supply for HBO mercury lamp is designed to be air-cooled with low noise and stable voltage. The unique automatic memory usage time and shutdown time can ensure the maximum cooling of the mercury lamp, protect the life of the mercury lamp and improve the mechanical performance.



Create a Personal Microscope

Help for your life science research to move forward

Viewing Head with Bertrand Lens

The built-in Bertrand lens device, in moving into the light path, can be used to observe the objective pupil, to the same role as the centering telescope.



Tiltable Illumination Frame

The tilting illumination frame ensures a large working space for the user to change samples.



Removable mechanical stage

The high-performance three-layer mechanical stage is flexible and accurate, and is equipped with a variety of stage mounting arms to accommodate many kinds of culture bottles and cell petri dishes.



Various Image Output Ports

An optical path output selection turnplate is located on the left side of the microscope to facilitate the distribution of optical images to different ports, providing additional room for more optical image applications.



Convenient operation

Microscope service status display

In order to facilitate the use of the microscope in the darkroom, a 4.3-inch touch display screen can be added on the front panel of the microscope (optional). Display microscope using state and adjust the microscope, including: Converter magnification screen display · multi-functional turntable band display · brightness screen display and memory · touch to adjust brightness · magnification display of touch screen and multi-functional turntable band display setting function.



Convenient lighting control

NIB900 scientific inverted microscope control button layout is reasonable, easy to operate, simplify the work flow. For example, transmission lighting switch and drop fluorescent lighting light switch control button are arranged on the right side of the fuselage.



System condenser meets various test requirements

Bright field, phase contrast, DIC variety of observation, for your experiment to provide maximum choice space.

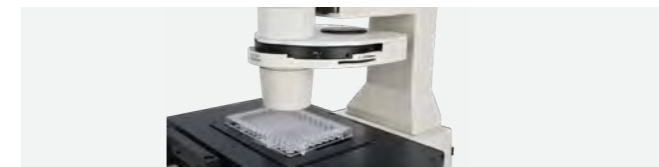

Intermediate magnification can be switched

Through smooth turntable operation, the intermediate magnification can achieve 1 times, 1.5 times fast switching.



Accessories

Load Stage

Equipped with Terasaki holder, 96-well plates, Ø38mm, Ø54mm petri dish holder to meet a variety of experiment needs.



Camera port

Provide 0.4x, 0.5x, 1X C interface for users to choose, used to connect cameras and other image acquisition systems.



N-iPLFN PH Plan Semi-apochromatic Objective

Multi-layer coating technology, semi-apochromatic objectives can compensate for spherical aberration and chromatic aberration from ultraviolet to near-infrared. The 20x and 40x semi-apochromatic objectives have a built-in calibration ring that corrects the difference in coverage caused by the non-standard thickness of the coverslip. Highly sensitive fluorescence properties ensure sharpness, clarity and color reproduction of the acquired image.



Fluorescent power

Mercury lamp light source

Standard OSRAM 100W HBO ultra-high pressure ballast mercury lamp, high fluorescence brightness, uniform field of view. At the same time, the front end of the vertical illuminator is provided with a light switch, which can cut off the fluorescent lighting at any time to protect the sample.



Metal halide light source

Optional 75W metal halide light source, lamp life up to 2000 hours. The light intensity is greater, and the field of view is brighter and more uniform.



LED light source

4 color LED light source, adjustable brightness, lamp life is up to tens of thousands of hours. Low phototoxicity, high friendly to fine samples such as cells, solves the problems of preheating and cooling of traditional mercury lamp fluorescence and too high temperature in use.



NOMIS Basic

New Revolution in Microscopic Observation

Today, the research work environment requires tools to adapt to each individual's workflow. NOMIS Basic microscopic image analysis software allows seamless integration between acquisition, processing, measurement and microscope. NOMIS Basic provides both observing tools for today's popular operating systems.

Quick Stitching

By acquiring and importing images in real time, NOMIS Basic can quickly stitching to form a large, high-resolution image.

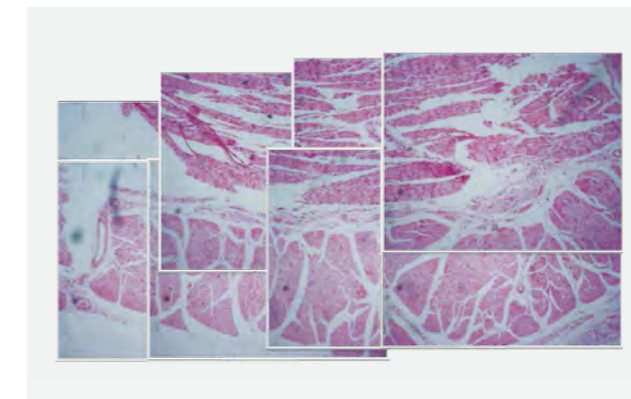

Fluorescence image synthesis

By collecting or importing images of different fluorescence channels, users can obtain the images after fluorescence synthesis. For the image of each channel, the displacement in X direction and Y direction can be adjusted to achieve the effect of fine adjustment.

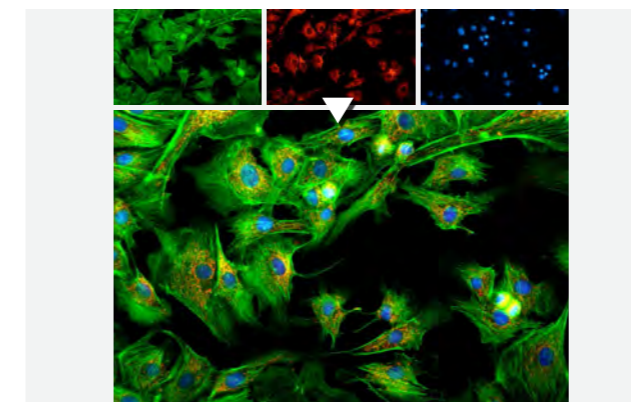

Measurement function

In cell and slice observations, measurement functions are required. To determine cell size, cell gap, synaptic length and other data. NOMIS Basic provides measurements of distance, angle, rectangle, circle, ellipse, etc.

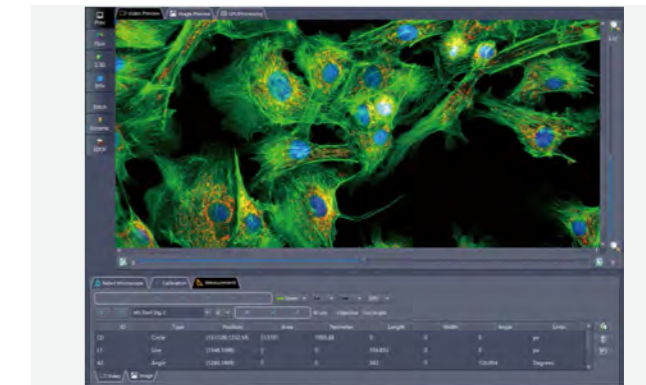

Cell count

It can customize cell counting requirements, automatically count and count cell shape information, including size, location, volume, perimeter, brightness and so on. And all data including processed images can be saved as EXCEL tables.



Depth of field fusion

The user can acquire multiple images of different focal lengths by fine-tuning the focal length and synthesize a picture output. Suitable for specimens that require a certain depth of field or poorly prepared sections.

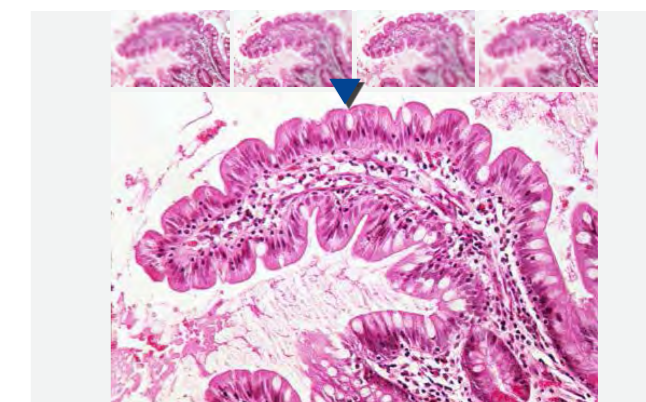

DIMENSION FIGURE

Unit: mm

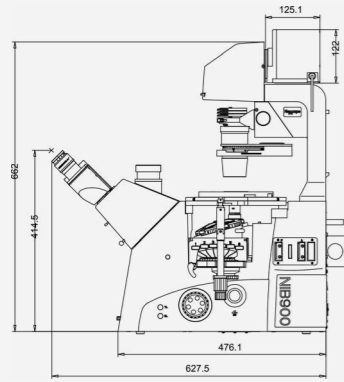

NIB910

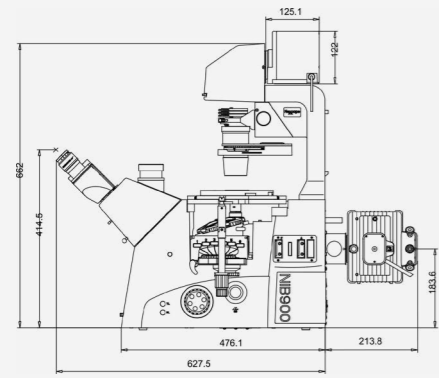
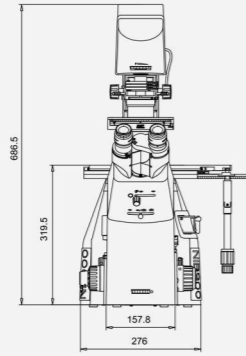

NIB910-FL

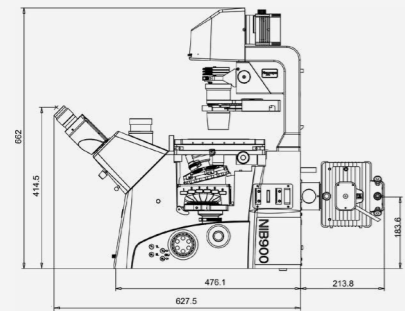
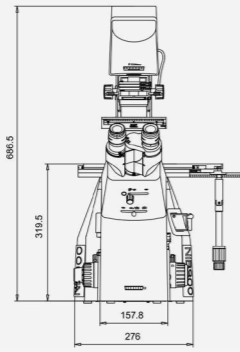

NIB950

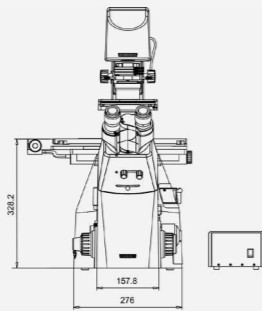

SYSTEM LAYOUT

